



## ± 2.5g Tri-axis Accelerometer Specifications

PART NUMBER:

KXSB5-2083  
Rev. 4  
May-2014

### Product Description

The KXSB5-2083 is a Tri-axis, silicon micromachined accelerometer with a full-scale output range of  $\pm 2.5g$  (24.5 m/s/s). The sense element is fabricated using Kionix's proprietary plasma micromachining process technology. Acceleration sensing is based on the principle of a differential capacitance arising from acceleration-induced motion of the sense element, which further utilizes common mode cancellation to decrease errors from process variation, temperature, and environmental stress. The sense element is hermetically sealed at the wafer level by bonding a second silicon lid wafer to the device using a glass frit. A separate ASIC device packaged with the sense element provides signal conditioning and self-test. The accelerometer is delivered in a 5 x 3 x 0.9 mm LGA plastic package operating from a 2.5 – 3.6V DC supply.

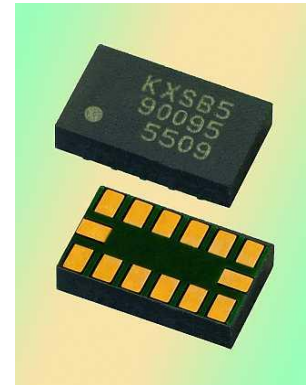

There are 4 factory programmable modes of operation for the KXSB5:

- Mode 00** – The three outputs (X, Y, Z) are read through the **digital** SPI interface, which is also used to command Selftest and Standby Mode. The digital I/O pads are powered from a separate power pin, and will interface to 1.8V logic.
- Mode 01** – The three outputs (X, Y, Z) are provided on three **analog** output pins. The KXSB5 also features an integrated **3-channel multiplexer** (X, Y, Z). The Enable pin must be **high** for normal operation and **low** for power shutdown.
- Mode 10** – The three outputs (X, Y, Z) are provided on three **analog** output pins. The KXSB5 also features an integrated **4-channel multiplexer** (X, Y, Z, Aux In). The Enable pin must be **high** for normal operation and **low** for power shutdown.
- Mode 11** – The three outputs (X, Y, Z) are provided on three **analog** output pins. The KXSB5 also features an integrated **4-channel multiplexer** (X, Y, Z, Aux In). The Enable pin must be **low** for normal operation and **high** for power shutdown.

**The KXSB5-2083 is factory programmed to be in MODE 11.**



# ± 2.5g Tri-axis Accelerometer Specifications

PART NUMBER:

KXSB5-2083  
Rev. 4  
May-2014

## Functional Diagram

### Mode 11

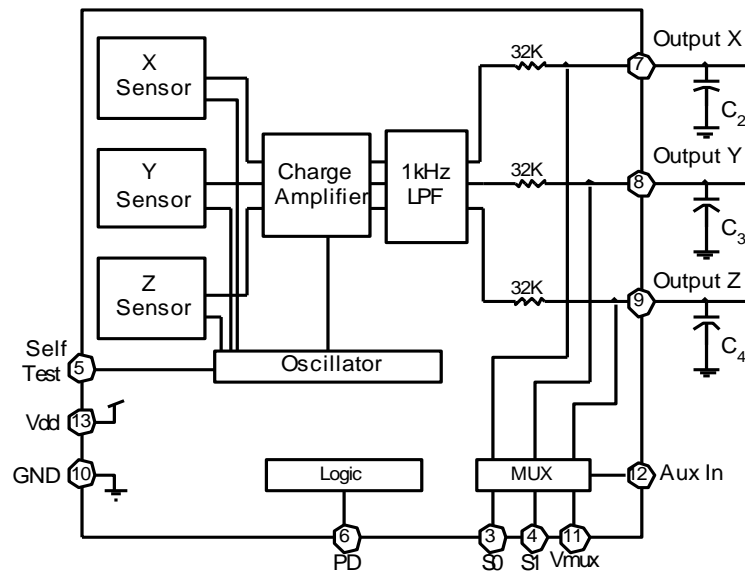



# ± 2.5g Tri-axis Accelerometer Specifications

**PART NUMBER:**

**KXSB5-2083  
Rev. 4  
May-2014**

## Product Specifications

**Table 1. Mechanical**

### Analog

(specifications are for operation at 2.5V and T = 25C unless stated otherwise)

Parameters	Units	Min	Typical	Max
Operating Temperature Range	°C	-10	-	85
Zero-g Offset	V	1.17	1.25	1.33
Zero-g Offset Variation from RT over Temp.	mg/°C		0.6	
Sensitivity	mV/g	388	400	412
Sensitivity Variation from RT over Temp.	%/°C		0.01 (xy) 0.03 (z)	
Offset Ratiometric Error ( $V_{dd} = 2.5V \pm 5\%$ )	%		0.3	1.5
Sensitivity Ratiometric Error ( $V_{dd} = 2.5V \pm 5\%$ )	%		0.6 (xy) 0.3 (z)	1.5 1.5
Self Test Output change on Activation	g	1.1 1.2 0.8	1.6 (x) 1.5 (y) 1.2 (z)	2 1.8 1.4
Non-Linearity	% of FS		0.1	
Cross Axis Sensitivity	%		2	
Noise Density (on filter pins)	$\mu\text{g} / \sqrt{\text{Hz}}$		175	



# ± 2.5g Tri-axis Accelerometer Specifications

**PART NUMBER:**

**KXSB5-2083  
Rev. 4  
May-2014**

**Table 2. Electrical**

**Analog**

(specifications are for operation at 2.5V and T = 25C unless stated otherwise)

Parameters		Units	Min	Typical	Max
Supply Voltage ( $V_{dd}$ )	Operating	V	2.375	2.5	3.6
	Operating (full power)	$\mu A$	300	500	700
Current Consumption	Standby	$\mu A$		1	
Input Low Voltage		V			$0.2 * V_{dd}$
Input High Voltage		V	$0.8 * V_{dd}$		
Analog Output Resistance( $R_{out}$ )		$k\Omega$	24	32	40
Power Up Time <sup>1</sup>		ms		1	
Bandwidth (-3dB) <sup>2</sup>		Hz	800	1000	1200

Notes:

1. Power up time can also be determined by 5 times the RC time constant of the optional user defined low pass filter.
2. Internal 1 kHz low pass filter. Lower frequencies are user definable with external capacitors.

	<b>± 2.5g Tri-axis Accelerometer Specifications</b>	<b>PART NUMBER:</b> <b>KXSB5-2083</b> <b>Rev. 4</b> <b>May-2014</b>
---	---	--

**Table 3. Environmental**

Parameters		Units	Min	Typical	Max
Supply Voltage (V <sub>dd</sub> )	Absolute Limits	V	-0.3	-	7.0
Operating Temperature Range		°C	-40	-	85
Storage Temperature Range		°C	-55	-	150
Mech. Shock (powered and unpowered)		g	-	-	5000 for 0.5ms
ESD	HBM	V	-	-	3000



Caution: ESD Sensitive and Mechanical Shock Sensitive Component, improper handling can cause permanent damage to the device.



This product conforms to Directive 2002/95/EC of the European Parliament and of the Council of the European Union (RoHS). Specifically, this product does not contain lead, mercury, cadmium, hexavalent chromium, polybrominated biphenyls (PBB), or polybrominated diphenyl ethers (PBDE) above the maximum concentration values (MCV) by weight in any of its homogenous materials. Homogenous materials are "of uniform composition throughout."



This product is halogen-free per IEC 61249-2-21. Specifically, the materials used in this product contain a maximum total halogen content of 1500 ppm with less than 900-ppm bromine and less than 900-ppm chlorine.

### Soldering

Soldering recommendations available upon request or from [www.kionix.com](http://www.kionix.com).



# ± 2.5g Tri-axis Accelerometer Specifications

PART NUMBER:

KXSB5-2083  
Rev. 4  
May-2014

## Application Schematic

Mode 11

Table 4. KXSB5 Pad Descriptions

Pad	Name	Description
1	Vdd	The power supply input. Decouple this pin to ground with a 0.1uF ceramic capacitor (C <sub>1</sub> ).
2	NC	Not Connected Internally (can be connected to Vdd)
3	S0	MUX selector 0 (See Output Select Table). Connect to Vdd or Ground if not used.
4	S1	MUX selector 1 (See Output Select Table). Connect to Vdd or Ground if not used.
5	ST	Self Test: <b>High</b> - Device is in self-test mode; <b>Low</b> - Normal operation
6	PD	Power shutdown: <b>Low</b> - Normal operation; <b>High</b> - Device is in standby, power down mode
7	X Output	Analog output of the x-channel. Optionally, a capacitor (C <sub>2</sub> ) placed between this pin and ground will form a low pass filter.
8	Y Output	Analog output of the y-channel. Optionally, a capacitor (C <sub>3</sub> ) placed between this pin and ground will form a low pass filter.
9	Z Output	Analog output of the z-channel. Optionally, a capacitor (C <sub>4</sub> ) placed between this pin and ground will form a low pass filter.
10	GND	Ground
11	Vmux	Multiplexed analog output. Float if the multiplexer is not used.
12	Aux In	Auxiliary input for multiplexer. Connect to Vdd or Ground if not used.
13	Vdd	The power supply input. Decouple this pin to ground with a 0.1uF ceramic capacitor (C <sub>1</sub> ).
14	Vdd	The power supply input. Decouple this pin to ground with a 0.1uF ceramic capacitor (C <sub>1</sub> ).

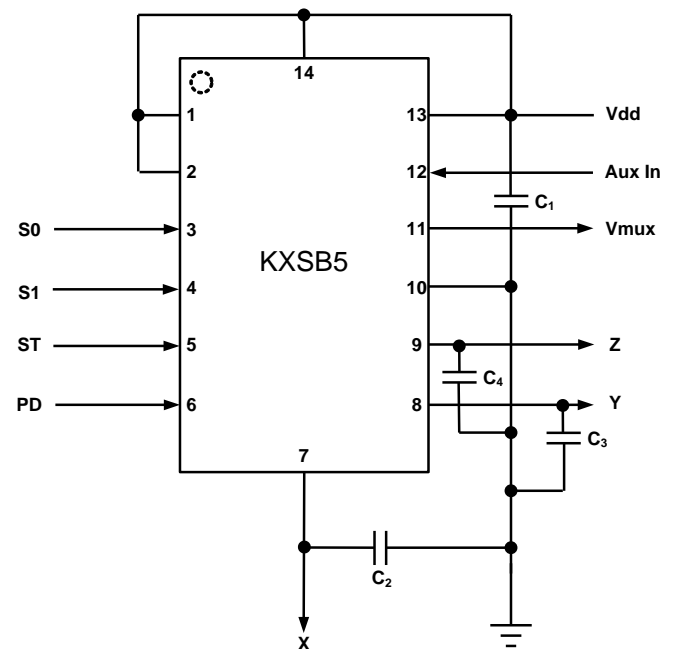

### **Important Technical Note: Power Up / Power Down**

Proper functioning of power-on reset (POR) is dependent on the specific Voff and Toff profile of individual applications. It is recommended to minimize Voff and maximize Toff. The application should be evaluated with the range of Voff and Toff expected within the application as POR performance can vary depending on these parameters. In order to guarantee proper reset regardless of Voff and Toff, a software reset can be issued via the SPI protocol. Please refer to Technical Note **KXRB5 and KXSB5 Accelerometer Reset Sequence** document to ensure proper POR function in your application.

	<b>± 2.5g Tri-axis Accelerometer Specifications</b>	<b>PART NUMBER:</b>  KXSB5-2083 Rev. 4 May-2014
---	---	---

***Application Design Equations***

The bandwidth is determined by the filter capacitors connected from pins 7, 8 and 9 to ground. The response is single pole. Given a desired bandwidth in Hz,  $f_{BW}$ , the filter capacitors are determined by:

$$C_2 = C_3 = C_4 = \frac{4.97 \times 10^{-6}}{f_{BW}}$$



## ± 2.5g Tri-axis Accelerometer Specifications

PART NUMBER:

KXSB5-2083  
Rev. 4  
May-2014

### USING THE MULTIPLEXED OUTPUT OF THE KXSB5

#### ***Multiplexer Data Select***

The KXSB5 features an integrated 4-channel multiplexer. This feature reduces system MCU requirements to only 1 ADC and 2 digital I/O's. The KXSB5 uses two select inputs (S0, S1) to control the data flow from Vmux. When a microprocessor toggles the select inputs, the desired output is attained based on the select table. Note that logic 0 is GND and logic 1 is Vdd.

S1	S0	Vmux
0	0	X Output
0	1	Y Output
1	0	Z Output
1	1	Aux In

Output Select Table

#### ***Data Sampling Rate***

When operating in its multiplexed mode, the KXSB5 has the ability to achieve very high data sampling rates. Internally, the sensor elements (X, Y, and Z) are sequentially sampled in a "round robin" fashion at a rate of 32 kHz per axis. Note that this is a differential capacitance sampling of each sensor element, which stores an analog voltage on the filter cap for each axis. Combine this high sensor element sampling rate with the short 5  $\mu$ s settling time of the integrated multiplexer, and the user can achieve a performance very close to that of the 3 separate analog outputs. This is more than sufficient to eliminate any aliasing in the final application since the KXSB5 will be operating with a typical bandwidth of ~50Hz and a maximum of 1000Hz.



	<b>± 2.5g Tri-axis Accelerometer Specifications</b>	<b>PART NUMBER:</b> <b>KXSB5-2083</b> <b>Rev. 4</b> <b>May-2014</b>
---	---	--

## Test Specifications

**!** *Special Characteristics:*

These characteristics have been identified as being critical to the customer. Every part is tested to verify its conformance to specification prior to shipment.

**Table 5. Test Specifications**

Parameter	Specification	Test Conditions
Zero-g Offset @ RT	1.25 +/- 0.08 V	25C, Vdd = 2.5 V
Sensitivity @ RT	400 +/- 12 mV/g	25C, Vdd = 2.5 V
Current Consumption -- Operating	300 <= Idd <= 700 uA	25C, Vdd = 2.5 V



# ± 2.5g Tri-axis Accelerometer Specifications

PART NUMBER:

KXSB5-2083  
Rev. 4  
May-2014

## Package Dimensions and Orientation

3 x 5 x 0.9 mm LGA

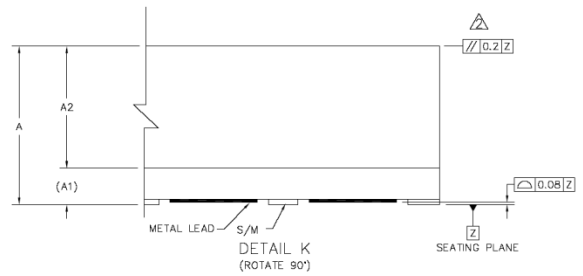
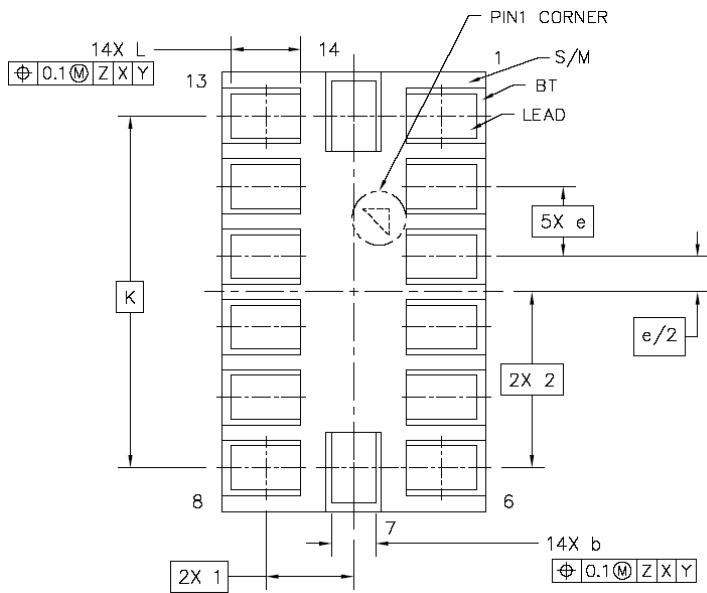
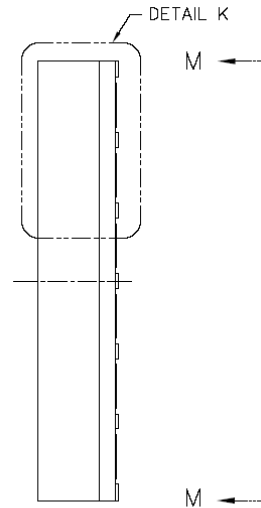
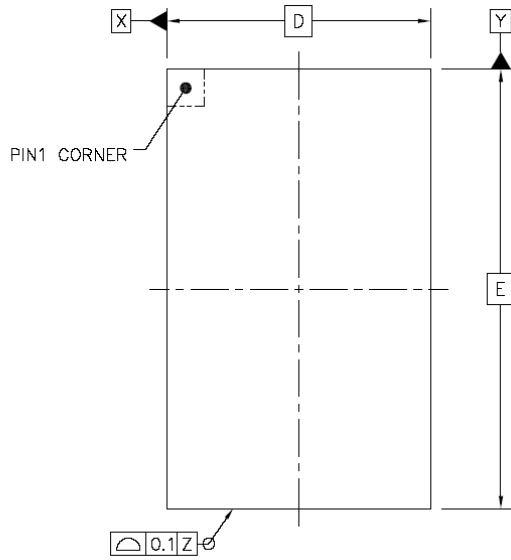



# ± 2.5g Tri-axis Accelerometer Specifications

**PART NUMBER:**

**KXSB5-2083  
Rev. 4  
May-2014**

Dimension	mm			inch		
	Min	Nom	Max	Min	Nom	Max
A	---	0.91	1.0	---	0.036	0.039
A1		0.21 REF			0.008 REF	
A2	0.66	0.7	0.74	0.026	0.028	0.029
b	0.45	0.5	0.55	0.018	0.020	0.022
D	2.8	3.0	3.2	0.110	0.118	0.126
E	4.8	5.0	5.2	0.189	0.197	0.205
K	3.9	4.0	4.1	0.153	0.157	0.161
e	0.78	0.8	0.82	0.030	0.031	0.032
L	0.75	0.8	0.85	0.029	0.031	0.033

All dimensions and tolerances conform to ASME Y14.5M-1994

## Orientation

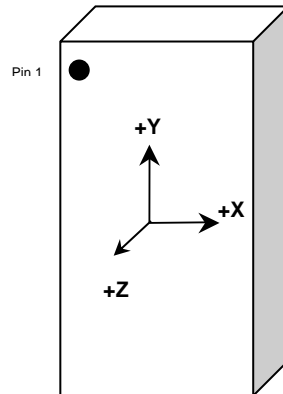

When device is accelerated in +X, +Y or +Z direction, the corresponding output will increase.







## ± 2.5g Tri-axis Accelerometer Specifications

**PART NUMBER:**

KXSB5-2083  
Rev. 4  
May-2014

### Static X/Y/Z Output Response versus Orientation to Earth's surface (1-g):

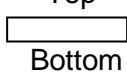
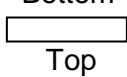
Position	1	2	3	4	5	6
Diagram						
X	1.25 V	1.65 V	1.25 V	0.85 V	1.25 V	1.25 V
Y	1.65 V	1.25 V	0.85 V	1.25 V	1.25 V	1.25 V
Z	1.25 V	1.25 V	1.25 V	1.25 V	1.65 V	0.85 V
X-Polarity	<b>0</b>	<b>+</b>	<b>0</b>	<b>-</b>	<b>0</b>	<b>0</b>
Y-Polarity	<b>+</b>	<b>0</b>	<b>-</b>	<b>0</b>	<b>0</b>	<b>0</b>
Z-Polarity	<b>0</b>	<b>0</b>	<b>0</b>	<b>0</b>	<b>+</b>	<b>-</b>

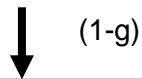

Earth's Surface

	<b>± 2.5g Tri-axis Accelerometer Specifications</b>	<b>PART NUMBER:</b> <b>KXSB5-2083</b> <b>Rev. 4</b> <b>May-2014</b>
---	---	--

**Revision History**

REVISION	DESCRIPTION	DATE
3	Update Maximum Operating voltage from 5.25V to 3.6V.	26-Feb-2013
4	Revised POR notes	08-May-2014

"Kionix" is a registered trademark of Kionix, Inc. Products described herein are protected by patents issued or pending. No license is granted by implication or otherwise under any patent or other rights of Kionix. The information contained herein is believed to be accurate and reliable but is not guaranteed. Kionix does not assume responsibility for its use or distribution. Kionix also reserves the right to change product specifications or discontinue this product at any time without prior notice. This publication supersedes and replaces all information previously supplied.