



## ± 2g Tri-axis Digital Accelerometer Specifications

PART NUMBER:  
KXTE9-2050  
Rev. 3  
Nov-2009

### Product Description

The KXTE9-2050 is a Tri-axis, silicon micromachined accelerometer with a full-scale output range of  $\pm 2g$  (19.6 m/s/s). The KXTE9 contains integrated orientation and activity detecting algorithms. The sense element is fabricated using Kionix's proprietary plasma micromachining process technology. Acceleration sensing is based on the principle of a differential capacitance arising from acceleration-induced motion of the sense element, which further utilizes common mode cancellation to decrease errors from process variation, temperature, and environmental stress. The sense element is hermetically sealed at the wafer level by bonding a second silicon lid wafer to the device using a glass frit. A separate ASIC device packaged with the sense element provides signal conditioning, digital communication, and embedded logic for orientation and activity detection. The accelerometer is delivered in a 3 x 3 x 0.9 mm LGA plastic package operating from a 1.8 – 3.6V DC supply. An I<sup>2</sup>C interface is used for communication with the chip to configure and check updates to the orientation and activity algorithms.

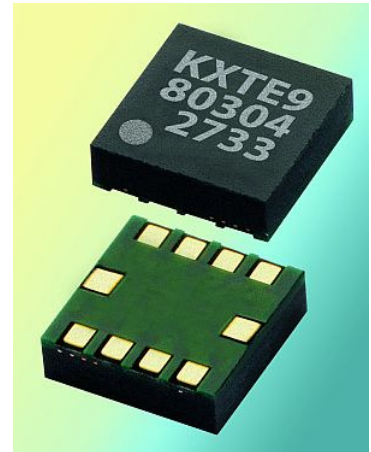

### Functional Diagram

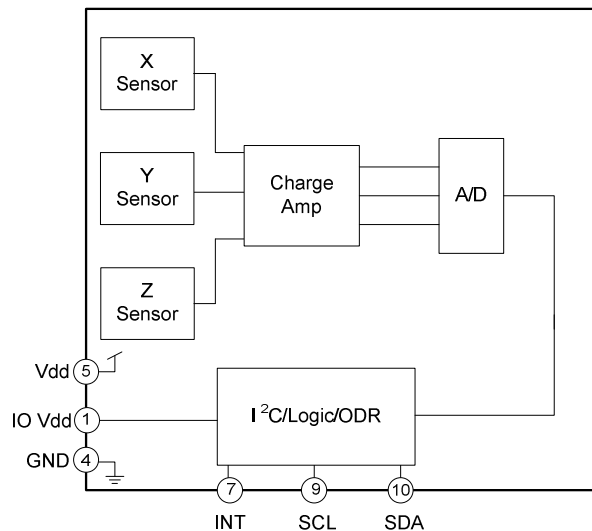

|   |   |  |
|---|---|--|
|  | <b>± 2g Tri-axis Digital Accelerometer<br/>Specifications</b> | <b>PART NUMBER:</b><br><b>KXTE9-2050</b><br><b>Rev. 3</b><br><b>Nov-2009</b> |
|---|---|--|

## Product Specifications

**Table 1. Mechanical**

(specifications are for operation at 3.3V and T = 25C unless stated otherwise)

| Parameters                                 | Units    | Min  | Typical               | Max  |
|--|----------|------|-----------------------|------|
| Operating Temperature Range                | °C       | -40  | -                     | 85   |
| Zero-g Offset                              | counts   |      | 32                    |      |
| Zero-g Offset Accuracy                     | mg       | -175 | 0                     | +175 |
| Zero-g Offset Variation from RT over Temp. | mg/°C    |      | 0.6                   |      |
| Sensitivity                                | counts/g |      | 16                    |      |
| Sensitivity Accuracy                       | %        | -10  | 0                     | +10  |
| Sensitivity Variation from RT over Temp.   | %/°C     |      | 0.01 (xy)<br>0.03 (z) |      |
| Non-Linearity                              | % of FS  |      | 0.1                   |      |
| Cross Axis Sensitivity                     | %        |      | 2                     |      |
| Resolution                                 | mg       |      | 62.5                  |      |

**Table 2. Electrical**

(specifications are for operation at 3.3V and T = 25C unless stated otherwise)

| Parameters   | Units                  | Min                   | Typical | Max                   |    |
|--|------------------------|-----------------------|---------|-----------------------|----|
| Supply Voltage (V <sub>dd</sub> ) <sup>1</sup> Operating | V                      | 1.8                   | 3.3     | 3.6                   |    |
| I/O Pads Supply Voltage (V <sub>io</sub> ) <sup>1</sup>  | V                      | 1.7                   |         | V <sub>dd</sub>       |    |
| Current Consumption                                      | Operating (full power) | μA                    | 20      | 30                    | 40 |
|  | Standby                |                       | -       | 0.1                   |    |
| Output Low Voltage <sup>2</sup>                          | V                      | -                     | -       | 0.3 * V <sub>io</sub> |    |
| Output High Voltage                                      | V                      | 0.9 * V <sub>io</sub> | -       | -                     |    |
| Input Low Voltage  | V                      | -                     | -       | 0.2 * V <sub>io</sub> |    |
| Input High Voltage                                       | V                      | 0.8 * V <sub>io</sub> | -       | -                     |    |
| Input Pull-down Current                                  | μA                     |                       | 0       |                       |    |
| Power Up Time <sup>3</sup>                               | ms                     |                       | 50.5    |                       |    |
| I <sup>2</sup> C Communication Rate                      | kHz                    |                       |         | 400                   |    |
| Output Data Rate (ODR) <sup>4</sup>                      | Hz                     | 1 NaN                 |         | 40                    |    |
| Bandwidth (-3dB)   | Hz                     |                       | 2000    |                       |    |

Notes:

1. Minimum voltage supply of 1.65V can be used over a reduced operating temperature range of 0°C to 45°C.
2. Assuming minimum 1.5Kohm I<sup>2</sup>C pull-up resistor on SCL and SDA.
3. Power up time is to V<sub>dd</sub> = valid and device is in active mode.
4. User selectable through I<sup>2</sup>C.

|   |   |  |
|---|---|--|
|  | <b>± 2g Tri-axis Digital Accelerometer Specifications</b> | <b>PART NUMBER:</b><br><b>KXTE9-2050</b><br><b>Rev. 3</b><br><b>Nov-2009</b> |
|---|---|--|

**Table 3. Environmental**

| Parameters                          |                 | Units | Min  | Typical | Max                               |
|-------------------------------------|-----------------|-------|------|---------|-----------------------------------|
| Supply Voltage ( $V_{dd}$ )         | Absolute Limits | V     | -0.3 | -       | 6.0                               |
| Operating Temperature Range         |                 | °C    | -40  | -       | 85                                |
| Storage Temperature Range           |                 | °C    | -55  | -       | 150                               |
| Mech. Shock (powered and unpowered) |                 | g     | -    | -       | 5000 for 0.5ms<br>10000 for 0.2ms |
| ESD                                 | HBM             | V     | -    | -       | 2000                              |



Caution: ESD Sensitive and Mechanical Shock Sensitive Component, improper handling can cause permanent damage to the device.



This product conforms to Directive 2002/95/EC of the European Parliament and of the Council of the European Union (RoHS). Specifically, this product does not contain lead, mercury, cadmium, hexavalent chromium, polybrominated biphenyls (PBB), or polybrominated diphenyl ethers (PBDE) above the maximum concentration values (MCV) by weight in any of its homogenous materials. Homogenous materials are "of uniform composition throughout."



This product is halogen-free per IEC 61249-2-21. Specifically, the materials used in this product contain a maximum total halogen content of 1500 ppm with less than 900-ppm bromine and less than 900-ppm chlorine.

### Soldering

Soldering recommendations are available upon request or from [www.kionix.com](http://www.kionix.com).



# ± 2g Tri-axis Digital Accelerometer Specifications

**PART NUMBER:**  
 KXTE9-2050  
 Rev. 3  
 Nov-2009

## Application Schematic

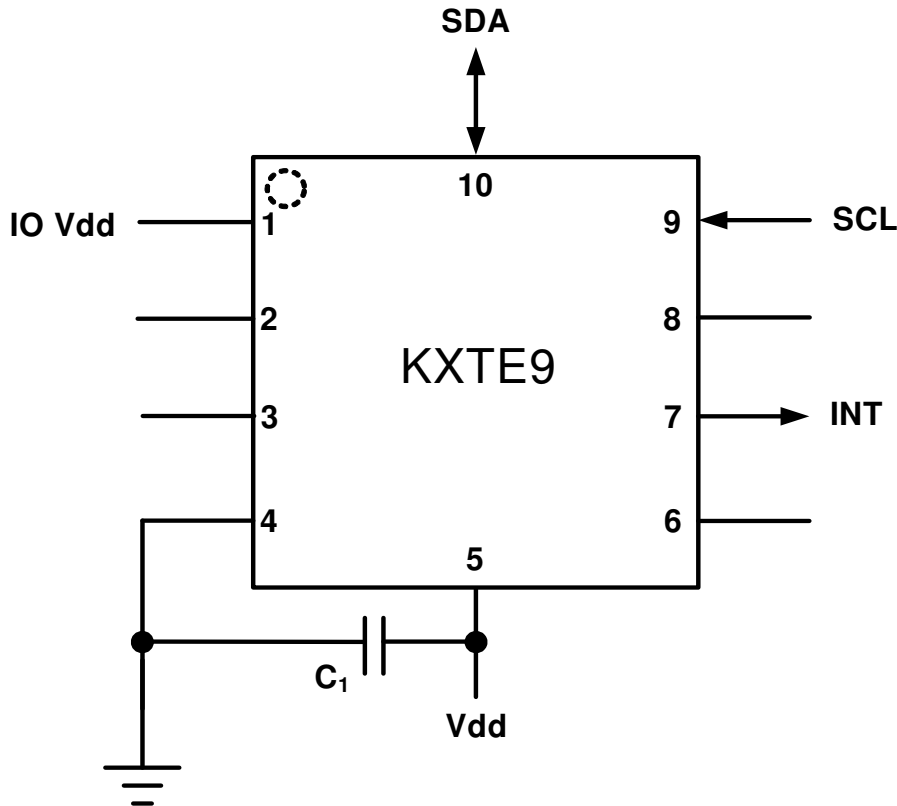

**Table 4. KXTE9 Pin Descriptions**

| Pin | Name   | Description   |
|-----|--------|---|
| 1   | IO Vdd | The power supply input for the digital communication bus                            |
| 2   | NC     | Not Connected internally – may be connected to Vdd or GND                           |
| 3   | NC     | Not Connected internally – may be connected to Vdd or GND                           |
| 4   | GND    | Ground  |
| 5   | Vdd    | The power supply input. Decouple this pin to ground with a 0.1uF ceramic capacitor. |
| 6   | NC     | Not Connected internally – may be connected to Vdd or GND                           |
| 7   | INT    | Interrupt pin (Reports user-defined state changes)                                  |
| 8   | NC     | Not Connected internally – may be connected to Vdd or GND                           |
| 9   | SCL    | I <sup>2</sup> C Serial Clock (requires 1.5kΩ pull-up resistor)                     |
| 10  | SDA    | I <sup>2</sup> C Serial Data (requires 1.5kΩ pull-up resistor)                      |



# ± 2g Tri-axis Digital Accelerometer Specifications

**PART NUMBER:**  
KXTE9-2050  
Rev. 3  
Nov-2009

## Test Specifications



### *Special Characteristics:*

These characteristics have been identified as being critical to the customer. Every part is tested to verify its conformance to specification prior to shipment.

**Table 5. Test Specifications**

| Parameter                        | Specification       | Test Conditions  |
|----------------------------------|---------------------|------------------|
| Zero-g Offset @ RT               | 32 +/- 2.8 counts   | 25C, Vdd = 3.3 V |
| Sensitivity @ RT                 | 16 +/- 1.6 counts/g | 25C, Vdd = 3.3 V |
| Current Consumption -- Operating | 20 <= Idd <= 40 uA  | 25C, Vdd = 3.3 V |



# ± 2g Tri-axis Digital Accelerometer Specifications

PART NUMBER:  
KXTE9-2050  
Rev. 3  
Nov-2009

## Package Dimensions and Orientation

3 x 3 x 0.9 mm LGA

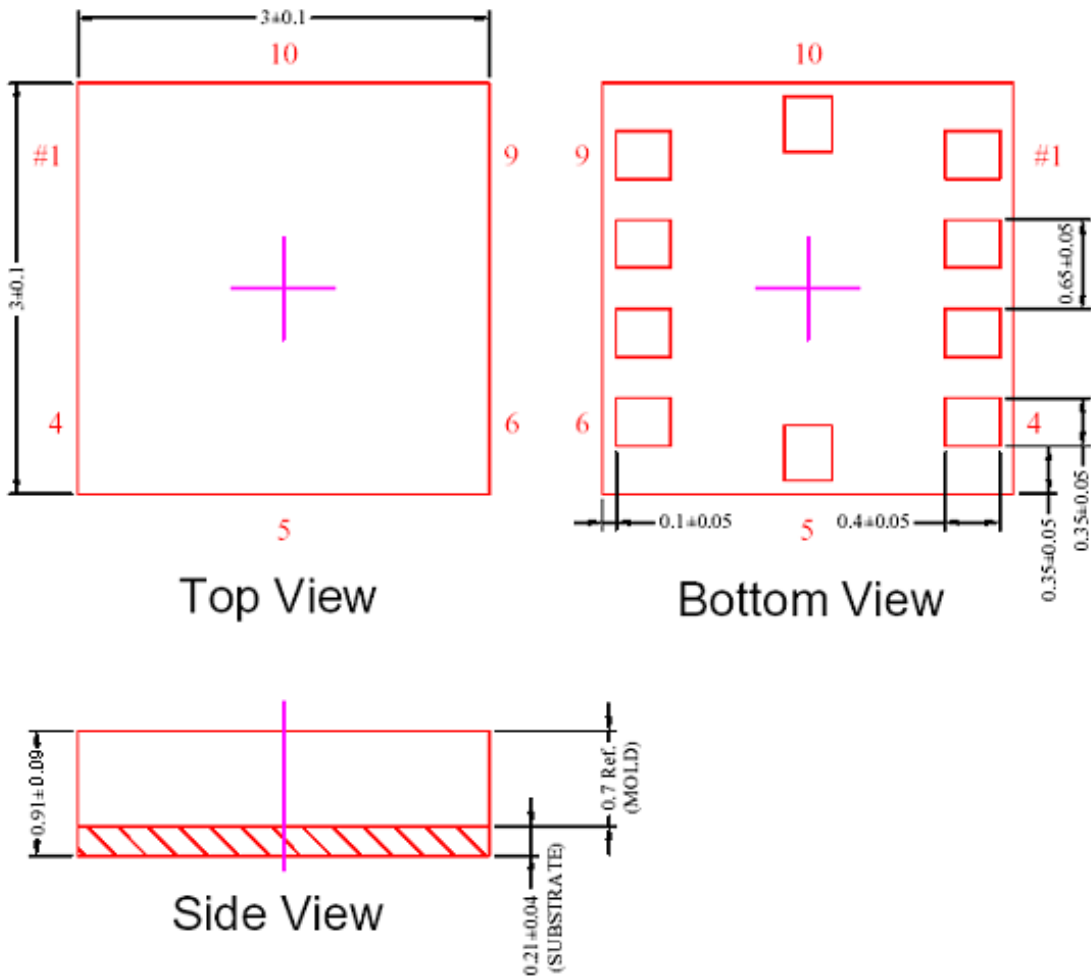

All dimensions and tolerances conform to ASME Y14.5M-1994



# ± 2g Tri-axis Digital Accelerometer Specifications

**PART NUMBER:**  
 KXTE9-2050  
 Rev. 3  
 Nov-2009

## Orientation

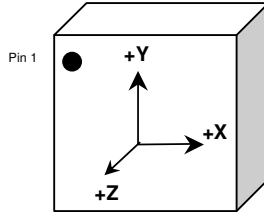

When device is accelerated in +X, +Y or +Z direction, the corresponding output will increase.

### Static X/Y/Z Output Response versus Orientation to Earth's surface (1g):

| Position | Up State (Y+) | Right State (X+) | Down State (Y-) | Left State (X-) | Face-Up State (Z+) | Face-Down State (Z-) |
|----------|---------------|------------------|-----------------|-----------------|--------------------|----------------------|
|----------|---------------|------------------|-----------------|-----------------|--------------------|----------------------|

| Position   | 1         | 2         | 3         | 4         | 5             | 6             |
|------------|-----------|-----------|-----------|-----------|---------------|---------------|
| Diagram    |           |           |           |           | Top<br>Bottom | Bottom<br>Top |
| X          | 32 counts | 48 counts | 32 counts | 16 counts | 32 counts     | 32 counts     |
| Y          | 48 counts | 32 counts | 16 counts | 32 counts | 32 counts     | 32 counts     |
| Z          | 32 counts | 32 counts | 32 counts | 32 counts | 48 counts     | 16 counts     |
| X-Polarity | 0         | +         | 0         | -         | 0             | 0             |
| Y-Polarity | +         | 0         | -         | 0         | 0             | 0             |
| Z-Polarity | 0         | 0         | 0         | 0         | +             | -             |

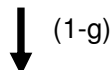

Earth's Surface

|   |   |  |
|---|---|--|
|  | <b>± 2g Tri-axis Digital Accelerometer<br/>Specifications</b> | <b>PART NUMBER:</b><br><b>KXTE9-2050</b><br><b>Rev. 3</b><br><b>Nov-2009</b> |
|---|---|--|

## KXTE9 Digital Interface

The Kionix KXTE9 digital accelerometer has the ability to communicate over an I<sup>2</sup>C digital serial interface bus. This flexibility eases system integration by eliminating analog-to-digital converter requirements and by providing direct communication with system micro-controllers.

The serial interface terms and descriptions indicated in Table 6 below will be observed throughout this document.

| Term        | Description  |
|-------------|--|
| Transmitter | The device that transmits data to the bus.   |
| Receiver    | The device that receives data from the bus.  |
| Master      | The device that initiates a transfer, generates clock signals and terminates a transfer. |
| Slave       | The device addressed by the Master.  |

**Table 6.** Serial Interface Terminologies

## I<sup>2</sup>C Serial Interface

The KXTE9 has the ability to communicate on an I<sup>2</sup>C bus. I<sup>2</sup>C is primarily used for synchronous serial communication between a Master device and one or more Slave devices. The Master, typically a micro controller, provides the serial clock signal and addresses Slave devices on the bus. The KXTE9 always operates as a Slave device during standard Master-Slave I<sup>2</sup>C operation.

I<sup>2</sup>C is a two-wire serial interface that contains a Serial Clock (SCL) line and a Serial Data (SDA) line. SCL is a serial clock that is provided by the Master, but can be held low by any Slave device, putting the Master into a wait condition. SDA is a bi-directional line used to transmit and receive data to and from the interface. Data is transmitted MSB (Most Significant Bit) first in 8-bit per byte format, and the number of bytes transmitted per transfer is unlimited. The I<sup>2</sup>C bus is considered free when both lines are high.

## I<sup>2</sup>C Operation

Transactions on the I<sup>2</sup>C bus begin after the Master transmits a start condition (S), which is defined as a high-to-low transition on the data line while the SCL line is held high. The bus is considered busy after this condition. The next byte of data transmitted after the start condition contains the Slave Address (SAD) in the seven MSBs (Most Significant Bits), and the LSB (Least Significant Bit) tells whether the Master will be receiving data '1' from the Slave or transmitting data '0' to the Slave. When a Slave Address is sent, each device on the bus compares the seven MSBs with its internally-stored address. If they match, the device considers itself addressed by the Master. The Slave Address associated with the KXTE9 is **0001111**.

It is mandatory that receiving devices acknowledge (ACK) each transaction. Therefore, the transmitter must release the SDA line during this ACK pulse. The receiver then pulls the data line low so that it remains stable low during the high period of the ACK clock pulse. A receiver that has been addressed, whether it is Master or Slave, is obliged to generate an ACK after each byte of data has been received. To



|   |   |  |
|---|---|--|
|  | <b>± 2g Tri-axis Digital Accelerometer<br/>Specifications</b> | <b>PART NUMBER:</b><br><b>KXTE9-2050</b><br><b>Rev. 3</b><br><b>Nov-2009</b> |
|---|---|--|

conclude a transaction, the Master must transmit a stop condition (P) by transitioning the SDA line from low to high while SCL is high. The I<sup>2</sup>C bus is now free.

### Writing to a KXTE9 8-bit Register

Upon power up, the Master must write to the KXTE9's control registers to set its operational mode. Therefore, when writing to a control register on the I<sup>2</sup>C bus, as shown Sequence 1 on the following page, the following protocol must be observed: After a start condition, SAD+W transmission, and the KXTE9 ACK has been returned, an 8-bit Register Address (RA) command is transmitted by the Master. This command is telling the KXTE9 to which 8-bit register the Master will be writing the data. Since this is I<sup>2</sup>C mode, the MSB of the RA command should always be zero (0). The KXTE9 acknowledges the RA and the Master transmits the data to be stored in the 8-bit register. The KXTE9 acknowledges that it has received the data and the Master transmits a stop condition (P) to end the data transfer. The data sent to the KXTE9 is now stored in the appropriate register. The KXTE9 automatically increments the received RA commands and, therefore, multiple bytes of data can be written to sequential registers after each Slave ACK as shown in Sequence 2 on the following page.

### Reading from a KXTE9 8-bit Register

When reading data from a KXTE9 8-bit register on the I<sup>2</sup>C bus, as shown in Sequence 3 on the next page, the following protocol must be observed: The Master first transmits a start condition (S) and the appropriate Slave Address (SAD) with the LSB set at '0' to write. The KXTE9 acknowledges and the Master transmits the 8-bit RA of the register it wants to read. The KXTE9 again acknowledges, and the Master transmits a repeated start condition (Sr). After the repeated start condition, the Master addresses the KXTE9 with a '1' in the LSB (SAD+R) to read from the previously selected register. The Slave then acknowledges and transmits the data from the requested register. The Master does not acknowledge (NACK) it received the transmitted data, but transmits a stop condition to end the data transfer. Note that the KXTE9 automatically increments through its sequential registers, allowing data to be read from multiple registers following a single SAD+R command as shown below in Sequence 4 on the following page.

If a receiver cannot transmit or receive another complete byte of data until it has performed some other function, it can hold SCL low to force the transmitter into a wait state. Data transfer only continues when the receiver is ready for another byte and releases SCL.



# ± 2g Tri-axis Digital Accelerometer Specifications

**PART NUMBER:**  
KXTE9-2050  
Rev. 3  
Nov-2009

## Data Transfer Sequences

The following information clearly illustrates the variety of data transfers that can occur on the I<sup>2</sup>C bus and how the Master and Slave interact during these transfers. Table 7 defines the I<sup>2</sup>C terms used during the data transfers.

| Term | Definition                |
|------|---------------------------|
| S    | Start Condition           |
| Sr   | Repeated Start Condition  |
| SAD  | Slave Address             |
| W    | Write Bit                 |
| R    | Read Bit                  |
| ACK  | Acknowledge               |
| NACK | Not Acknowledge           |
| RA   | Register Address          |
| Data | Transmitted/Received Data |
| P    | Stop Condition            |

**Table 7.** I<sup>2</sup>C Terms

**Sequence 1.** The Master is writing one byte to the Slave.

|        |   |         |     |    |     |      |     |   |
|--------|---|---------|-----|----|-----|------|-----|---|
| Master | S | SAD + W |     | RA |     | DATA |     | P |
| Slave  |   |         | ACK |    | ACK |      | ACK |   |

**Sequence 2.** The Master is writing multiple bytes to the Slave.

|        |   |         |     |    |     |      |     |      |     |   |
|--------|---|---------|-----|----|-----|------|-----|------|-----|---|
| Master | S | SAD + W |     | RA |     | DATA |     | DATA |     | P |
| Slave  |   |         | ACK |    | ACK |      | ACK |      | ACK |   |

**Sequence 3.** The Master is receiving one byte of data from the Slave.

|        |   |         |     |    |     |    |         |     |      |      |   |
|--------|---|---------|-----|----|-----|----|---------|-----|------|------|---|
| Master | S | SAD + W |     | RA |     | Sr | SAD + R |     |      | NACK | P |
| Slave  |   |         | ACK |    | ACK |    |         | ACK | DATA |      |   |

**Sequence 4.** The Master is receiving multiple bytes of data from the Slave.

|        |   |         |     |    |     |    |         |     |      |     |      |      |   |
|--------|---|---------|-----|----|-----|----|---------|-----|------|-----|------|------|---|
| Master | S | SAD + W |     | RA |     | Sr | SAD + R |     |      | ACK |      | NACK | P |
| Slave  |   |         | ACK |    | ACK |    |         | ACK | DATA |     | DATA |      |   |



# ± 2g Tri-axis Digital Accelerometer Specifications

**PART NUMBER:**  
**KXTE9-2050**  
**Rev. 3**  
**Nov-2009**

## KXTE9 Embedded Registers

The KXTE9's 23 embedded 8-bit registers that are accessible via I<sup>2</sup>C are listed in Table 8.

| Register Name | Type<br>Read/Write | Address     |           |
|---------------|--------------------|-------------|-----------|
|               |                    | Hex         | Binary    |
| CT_RESP       | R                  | 0x0C        | 0000 1100 |
| Reserved      | -                  | 0x0D        | 0000 1101 |
| Reserved      | -                  | 0x0E        | 0000 1110 |
| WHO_AM_I      | R                  | 0x0F        | 0000 1111 |
| TILT_POS_CUR  | R                  | 0x10        | 0001 0000 |
| TILT_POS_PRE  | R                  | 0x11        | 0001 0001 |
| XOUT          | R                  | 0x12        | 0001 0010 |
| YOUT          | R                  | 0x13        | 0001 0011 |
| ZOUT          | R                  | 0x14        | 0001 0100 |
| Not Used      | -                  | 0x15        | 0001 0101 |
| INT_SRC_REG1  | R                  | 0x16        | 0001 0110 |
| INT_SRC_REG2  | R                  | 0x17        | 0001 0111 |
| STATUS_REG    | R                  | 0x18        | 0001 1000 |
| Not Used      | -                  | 0x19        | 0001 1001 |
| INT_REL       | R                  | 0x1A        | 0001 1010 |
| CTRL_REG1     | R/W                | 0x1B        | 0001 1011 |
| CTRL_REG2     | R/W                | 0x1C        | 0001 1100 |
| CTRL_REG3     | R/W                | 0x1D        | 0001 1101 |
| INT_CTRL_REG1 | R/W                | 0x1E        | 0001 1110 |
| INT_CTRL_REG2 | R/W                | 0x1F        | 0001 1111 |
| Not Used      | -                  | 0x20 – 0x27 | -         |
| TILT_TIMER    | R/W                | 0x28        | 0010 1000 |
| WUF_TIMER     | R/W                | 0x29        | 0010 1001 |
| B2S_TIMER     | R/W                | 0x2A        | 0010 1010 |
| Reserved      | -                  | 0x2B – 0x59 | -         |
| WUF_THRESH    | R/W                | 0x5A        | 0101 1010 |
| B2S_THRESH    | R/W                | 0x5B        | 0101 1011 |
| TILT_ANGLE    | R/W                | 0x5C        | 0101 1010 |
| Reserved      | -                  | 0x5D – 0x5E | -         |
| HYST_SET      | R/W                | 0x5F        | 0101 1111 |

**Table 8.** KXTE9 Register Map



# ± 2g Tri-axis Digital Accelerometer Specifications

**PART NUMBER:**  
KXTE9-2050  
Rev. 3  
Nov-2009

## KXTE9 Register Descriptions

### CT\_RESP

This register has a byte value of 0x55h except when the CTC bit in CTRL\_REG3 is set, this value is set to 0xAAh. The byte value is returned to 0x55h after each reading.

|      |      |      |      |      |      |      |      |             |
|------|------|------|------|------|------|------|------|-------------|
| R    | R    | R    | R    | R    | R    | R    | R    | Reset Value |
| STR7 | STR6 | STR5 | STR4 | STR3 | STR2 | STR1 | STR0 | 01010101    |
| Bit7 | Bit6 | Bit5 | Bit4 | Bit3 | Bit2 | Bit1 | Bit0 |             |

I<sup>2</sup>C Address: 0x0Ch

### WHO\_AM\_I

This register can be used for supplier recognition, as it can be factory written to a known byte value. The default value is 0x00h.

|      |      |      |      |      |      |      |      |             |
|------|------|------|------|------|------|------|------|-------------|
| R    | R    | R    | R    | R    | R    | R    | R    | Reset Value |
| WIA7 | WIA6 | WIA5 | WIA4 | WIA3 | WIA2 | WIA1 | WIA0 | 00000000    |
| Bit7 | Bit6 | Bit5 | Bit4 | Bit3 | Bit2 | Bit1 | Bit0 |             |

I<sup>2</sup>C Address: 0x0Fh

## Tilt Position Registers

These two registers report previous and current position data that is updated at the user-defined ODR frequency and is protected during register read. Table 9 describes the reported position for each bit value

### TILT\_POS\_CUR

Current tilt position register

|      |      |      |      |      |      |      |      |             |
|------|------|------|------|------|------|------|------|-------------|
| R    | R    | R    | R    | R    | R    | R    | R    | Reset Value |
| 0    | 0    | LE   | RI   | DO   | UP   | FD   | FU   | 00100000    |
| Bit7 | Bit6 | Bit5 | Bit4 | Bit3 | Bit2 | Bit1 | Bit0 |             |

I<sup>2</sup>C Address: 0x10h

### TILT\_POS\_PRE

Previous tilt position register

|      |      |      |      |      |      |      |      |             |
|------|------|------|------|------|------|------|------|-------------|
| R    | R    | R    | R    | R    | R    | R    | R    | Reset Value |
| 0    | 0    | LE   | RI   | DO   | UP   | FD   | FU   | 00100000    |
| Bit7 | Bit6 | Bit5 | Bit4 | Bit3 | Bit2 | Bit1 | Bit0 |             |

I<sup>2</sup>C Address: 0x11h



# ± 2g Tri-axis Digital Accelerometer Specifications

**PART NUMBER:**  
KXTE9-2050  
Rev. 3  
Nov-2009

| Bit | Description          |
|-----|----------------------|
| LE  | Left State (X-)      |
| RI  | Right State (X+)     |
| DO  | Down State (Y-)      |
| UP  | Up State (Y+)        |
| FD  | Face-Down State (Z-) |
| FU  | Face-Up State (Z+)   |

**Table 9.** KXTE9 Tilt Position

### Accelerometer Outputs

These registers contain 6-bits of valid acceleration data for each axis. The data is updated every ODR period and can be converted from digital counts to acceleration (g) using Equation 1.

$$\text{Acceleration (g)} = (\text{Output (counts)} - 0\text{g Offset (counts)}) / \text{Sensitivity (counts/g)}$$

**Equation 1.** Acceleration (g) Calculation

### XOUT

X-axis acceleration output (6-bit valid and updated every ODR period)

|        |        |        |        |        |        |      |      |
|--------|--------|--------|--------|--------|--------|------|------|
| R      | R      | R      | R      | R      | R      | R    | R    |
| XOUTD5 | XOUTD4 | XOUTD3 | XOUTD2 | XOUTD1 | XOUTD0 | X    | X    |
| Bit7   | Bit6   | Bit5   | Bit4   | Bit3   | Bit2   | Bit1 | Bit0 |

I<sup>2</sup>C Address: 0x12h

### YOUT

Y-axis acceleration output (6-bit valid and updated every ODR period)

|        |        |        |        |        |        |      |      |
|--------|--------|--------|--------|--------|--------|------|------|
| R      | R      | R      | R      | R      | R      | R    | R    |
| YOUTD5 | YOUTD4 | YOUTD3 | YOUTD2 | YOUTD1 | YOUTD0 | X    | X    |
| Bit7   | Bit6   | Bit5   | Bit4   | Bit3   | Bit2   | Bit1 | Bit0 |

I<sup>2</sup>C Address: 0x13h

### ZOUT

Z-axis acceleration output (6-bit valid and updated every ODR period)

|        |        |        |        |        |        |      |      |
|--------|--------|--------|--------|--------|--------|------|------|
| R      | R      | R      | R      | R      | R      | R    | R    |
| ZOUTD5 | ZOUTD4 | ZOUTD3 | ZOUTD2 | ZOUTD1 | ZOUTD0 | X    | X    |
| Bit7   | Bit6   | Bit5   | Bit4   | Bit3   | Bit2   | Bit1 | Bit0 |

I<sup>2</sup>C Address: 0x14h



# ± 2g Tri-axis Digital Accelerometer Specifications

**PART NUMBER:**  
KXTE9-2050  
Rev. 3  
Nov-2009

## Interrupt Source Registers

These two registers report function state changes. Data may be updated at every ODR period.

### INT\_SRC\_REG1

This register reports which function caused an interrupt.

|      |      |      |      |      |      |      |      |
|------|------|------|------|------|------|------|------|
| R    | R    | R    | R    | R    | R    | R    | R    |
| 0    | 0    | 0    | 0    | 0    | B2SS | WUFS | TPS  |
| Bit7 | Bit6 | Bit5 | Bit4 | Bit3 | Bit2 | Bit1 | Bit0 |

I<sup>2</sup>C Address: 0x16h

**B2SS** reflects the status of the inactivity/back to sleep function.  
*B2SS = 0 – activity state has not changed to inactive*  
*B2SS = 1 – activity state has changed to inactive*

**WUFS** reflects the status of the activity/wake up function.  
*WUFS = 0 – activity state has not changed to active*  
*WUFS = 1 – activity state has changed to active*

**TPS** reflects the status of the tilt position function.  
*TPS = 0 – tilt position state has not changed*  
*TPS = 1 – tilt position state has changed*

### INT\_SRC\_REG2

This register reports which axis and direction caused the activity state to transition from inactive to active per Table 10.

|      |      |      |      |      |      |      |      |
|------|------|------|------|------|------|------|------|
| R    | R    | R    | R    | R    | R    | R    | R    |
| 0    | 0    | ALE  | ARI  | ADO  | AUP  | AFD  | AFU  |
| Bit7 | Bit6 | Bit5 | Bit4 | Bit3 | Bit2 | Bit1 | Bit0 |

I<sup>2</sup>C Address: 0x17h

| Bit | Description              |
|-----|--------------------------|
| ALE | X Negative (X-) Reported |
| ARI | X Positive (X+) Reported |
| ADO | Y Negative (Y-) Reported |
| AUP | Y Positive (Y+) Reported |
| AFD | Z Negative (Z-) Reported |
| AFU | Z Positive (Z+) Reported |

**Table 10.** KXTE9 Activity Reporting



# ± 2g Tri-axis Digital Accelerometer Specifications

**PART NUMBER:**  
KXTE9-2050  
Rev. 3  
Nov-2009

## STATUS\_REG

This register reports the state of the interrupt and the status of information pertaining to the ODR setting.

|      |      |      |      |       |       |      |      |
|------|------|------|------|-------|-------|------|------|
| R    | R    | R    | R    | R     | R     | R    | R    |
| 0    | 0    | DOR  | INT  | SODRA | SODRB | 0    | 0    |
| Bit7 | Bit6 | Bit5 | Bit4 | Bit3  | Bit2  | Bit1 | Bit0 |

I<sup>2</sup>C Address: 0x18h

**DOR (output data overrun)** bit is released after the next output data register read

DOR = 0 – no data overrun

DOR = 1 – data is overrun

**INT** reports the combined interrupt information of all enabled functions. This bit is released to 0 when the interrupt release register (1Ah) is read.

INT = 0 – no interrupt event

INT = 1 – interrupt event has occurred

**SODRA** reports the status of the current ODRA setting that is being used.

**SODRB** reports the status of the current ODRB setting that is being used.

## INT\_REL

Latched interrupt source information is cleared and the physical interrupt latched pin (7) is set to the inactive state when this register is read.

|      |      |      |      |      |      |      |      |
|------|------|------|------|------|------|------|------|
| R    | R    | R    | R    | R    | R    | R    | R    |
| X    | X    | X    | X    | X    | X    | X    | X    |
| Bit7 | Bit6 | Bit5 | Bit4 | Bit3 | Bit2 | Bit1 | Bit0 |

I<sup>2</sup>C Address: 0x1Ah

## CTRL\_REG1

Read/write control register that controls the main feature set.

|      |      |      |      |      |      |      |      |             |
|------|------|------|------|------|------|------|------|-------------|
| R/W  | R/W  | R/W  | R/W  | R/W  | R/W  | R/W  | R/W  | Reset Value |
| PC1  | 0    | 0    | ODRA | ODRB | B2SE | WUFE | TPE  | 00000000    |
| Bit7 | Bit6 | Bit5 | Bit4 | Bit3 | Bit2 | Bit1 | Bit0 |             |

I<sup>2</sup>C Address: 0x1Bh

**PC1** controls the operating mode of the KXTE9.

PC1 = 0 - stand-by mode

PC1 = 1 - operating mode

**ODRA** sets the initial output data rate per Table 11.

|   |   |  |
|---|---|--|
|  | <b>± 2g Tri-axis Digital Accelerometer<br/>Specifications</b> | <b>PART NUMBER:</b><br><b>KXTE9-2050</b><br><b>Rev. 3</b><br><b>Nov-2009</b> |
|---|---|--|

**ODRB** sets the initial output data rate per Table 11.

| ODRA | ODRB | Output Data Rate |
|------|------|------------------|
| 0    | 0    | 1Hz              |
| 0    | 1    | 3Hz              |
| 1    | 0    | 10Hz             |
| 1    | 1    | 40Hz             |

**Table 11.** Initial Output Data Rate

**B2SE** enables the Back To Sleep function that will detect a transition from active mode to inactive mode.

*B2SE = 0 - disable*

*B2SE = 1- enable*

**WUFE** enables the Wake Up function that will detect a transition from inactive mode to active mode.

*WUFE = 0 - disable*

*WUFE = 1- enable*

**TPE** enables the Tilt Position function that will detect changes in device orientation.

*TPE = 0 - disable*

*TPE = 1- enable*

### CTRL\_REG2

Read/write control register that controls tilt position state masking. Per Table 12, if a state's bit is set to one (1), the state change will generate an interrupt. If it is set to zero (0), the state change will not generate an interrupt.

|      |      |      |      |      |      |      |      |             |
|------|------|------|------|------|------|------|------|-------------|
| R/W  | R/W  | R/W  | R/W  | R/W  | R/W  | R/W  | R/W  | Reset Value |
| 0    | 0    | LEM  | RIM  | DOM  | UPM  | FDM  | FUM  | 00111111    |
| Bit7 | Bit6 | Bit5 | Bit4 | Bit3 | Bit2 | Bit1 | Bit0 |             |

I<sup>2</sup>C Address: 0x1Ch

| Bit | Description          |
|-----|----------------------|
| LEM | Left State Mask      |
| RIM | Right State Mask     |
| DOM | Down State Mask      |
| UPM | Up State Mask        |
| FDM | Face-Down State Mask |
| FUM | Face-Up State Mask   |

**Table 12.** Tilt Position State Mask



|   |   |   |
|---|---|---|
|  | <b>± 2g Tri-axis Digital Accelerometer<br/>Specifications</b> | <b>PART NUMBER:</b><br>KXTE9-2050<br>Rev. 3<br>Nov-2009 |
|---|---|---|

### CTRL\_REG3

Read/write control register that provides more feature set control.

|      |      |      |      |       |       |       |       |             |
|------|------|------|------|-------|-------|-------|-------|-------------|
| R/W  | R/W  | R/W  | R/W  | R/W   | R/W   | R/W   | R/W   | Reset Value |
| SRST | 0    | 0    | CTC  | OB2SA | OB2SB | OWUFA | OWUFB | 0000110     |
| Bit7 | Bit6 | Bit5 | Bit4 | Bit3  | Bit2  | Bit1  | Bit0  |             |

I<sup>2</sup>C Address: 0x1Dh

**SRST** initiates software reset, which returns the internal RAM to Kionix default values.  
 This bit will remain high (1) for approximately 50 ms until the RAM load is finished.  
 SRST = 0 - no action or software reset has finished  
 SRST = 1 - start software reset

**CTC** initiates the communication-test function.  
 CTC = 0 - no action  
 CTC = 1 - sets CT\_RESP register to 0xAAh and when CT\_RESP is read, sets this bit to 0 and sets CT\_RESP to 0x55h

**OB2SA** sets the output data rate when in the inactive mode per Table 13.  
**OB2SB** sets the output data rate when in the inactive mode per Table 13.

| OB2SA | OB2SB | Output Data Rate |
|-------|-------|------------------|
| 0     | 0     | 1Hz              |
| 0     | 1     | 3Hz              |
| 1     | 0     | 10Hz             |
| 1     | 1     | 40Hz             |

**Table 13.** Inactive Mode Output Data Rate

**OWUFA** sets the output data rate when in the active mode per Table 14.  
**OWUFB** sets the output data rate when in the active mode per Table 14.

| OWUFA | OWUFB | Output Data Rate |
|-------|-------|------------------|
| 0     | 0     | 1Hz              |
| 0     | 1     | 3Hz              |
| 1     | 0     | 10Hz             |
| 1     | 1     | 40Hz             |

**Table 14.** Active Mode Output Data Rate



# ± 2g Tri-axis Digital Accelerometer Specifications

**PART NUMBER:**  
KXTE9-2050  
Rev. 3  
Nov-2009

## INT\_CTRL\_REG1

This register controls the settings for the physical interrupt pin (7).

|      |      |      |      |      |      |      |      |             |
|------|------|------|------|------|------|------|------|-------------|
| R/W  | R/W  | R/W  | R/W  | R/W  | R/W  | R/W  | R/W  | Reset Value |
| 0    | 0    | 0    | IEN  | IEA  | IEL  | 0    | 0    | 00001000    |
| Bit7 | Bit6 | Bit5 | Bit4 | Bit3 | Bit2 | Bit1 | Bit0 |             |

I<sup>2</sup>C Address: 0x1Eh

**IEN** enables/disables the physical interrupt pin (7)  
*IEN = 0 - physical interrupt pin (7) is disabled*  
*IEN = 1 - physical interrupt pin (7) is enabled*

**IEA** sets the polarity of the physical interrupt pin (7)  
*IEA = 0 - polarity of the physical interrupt pin (7) is active low*  
*IEA = 1 - polarity of the physical interrupt pin (7) is active high*

**IEL** sets the response of the physical interrupt pin (7)  
*IEL = 0 - the physical interrupt pin (7) latches until it is cleared by reading INT\_REL*  
*IEL = 1 - the physical interrupt pin (7) will transmit one pulse with a period of 0.05 ms*

## INT\_CTRL\_REG2

This register controls activity/inactivity state masking. Per Table 15, if a state's bit is set to one (1), the state change will generate an interrupt. If it is set to zero (0), the state change will not generate an interrupt.

|      |      |      |      |      |      |      |      |             |
|------|------|------|------|------|------|------|------|-------------|
| R/W  | R/W  | R/W  | R/W  | R/W  | R/W  | R/W  | R/W  | Reset Value |
| XBW  | YBW  | ZBW  | 0    | 0    | 0    | 0    | 0    | 11100000    |
| Bit7 | Bit6 | Bit5 | Bit4 | Bit3 | Bit2 | Bit1 | Bit0 |             |

I<sup>2</sup>C Address: 0x1Fh

| Bit | Description       |
|-----|-------------------|
| XBW | X-Axis State Mask |
| YBW | Y-Axis State Mask |
| ZBW | Z-Axis State Mask |

**Table 15.** Activity/Inactivity State Mask



## ± 2g Tri-axis Digital Accelerometer Specifications

**PART NUMBER:**  
KXTE9-2050  
Rev. 3  
Nov-2009

### TILT\_TIMER

This register is the programmable count register for the tilt position state timer (0 to 255 counts). Every count is calculated as 1/ODR delay period. A new state must be valid as many measurement periods before the change is accepted.

| R/W  | R/W  | R/W  | R/W  | R/W  | R/W  | R/W  | R/W  | Reset Value |
|------|------|------|------|------|------|------|------|-------------|
| TSC7 | TSC6 | TSC5 | TSC4 | TSC3 | TSC2 | TSC1 | TSC0 | 00000000    |
| Bit7 | Bit6 | Bit5 | Bit4 | Bit3 | Bit2 | Bit1 | Bit0 |             |

I<sup>2</sup>C Address: 0x28h

### WUF\_TIMER

This register is the programmable count register for the inactivity to activity timer (0 to 255 counts). Every count is calculated as 1/ODR delay period. A new state must be valid as many measurement periods before the change is accepted.

| R/W   | R/W   | R/W   | R/W   | R/W   | R/W   | R/W   | R/W   | Reset Value |
|-------|-------|-------|-------|-------|-------|-------|-------|-------------|
| WUFC7 | WUFC6 | WUFC5 | WUFC4 | WUFC3 | WUFC2 | WUFC1 | WUFC0 | 00000000    |
| Bit7  | Bit6  | Bit5  | Bit4  | Bit3  | Bit2  | Bit1  | Bit0  |             |

I<sup>2</sup>C Address: 0x29h

### B2S\_TIMER

This register is the programmable count register for the activity to inactivity timer (0 to 255 counts). Every count is calculated as 16\*(1/ODR) delay period. A new state must be valid as many measurement periods before the change is accepted.

| R/W   | R/W   | R/W   | R/W   | R/W   | R/W   | R/W   | R/W   | Reset Value |
|-------|-------|-------|-------|-------|-------|-------|-------|-------------|
| B2SC7 | B2SC6 | B2SC5 | B2SC4 | B2SC3 | B2SC2 | B2SC1 | B2SC0 | 00000000    |
| Bit7  | Bit6  | Bit5  | Bit4  | Bit3  | Bit2  | Bit1  | Bit0  |             |

I<sup>2</sup>C Address: 0x2Ah

### WUF\_THRESH

This register sets the WUF Threshold that is used to detect the transition from inactivity to activity. The KXTE9 ships from the factory with WUF\_THRESH set to a change in acceleration of 0.5g.

| R/W    | R/W    | R/W    | R/W    | R/W    | R/W    | R/W    | R/W    | Reset Value |
|--------|--------|--------|--------|--------|--------|--------|--------|-------------|
| WUFTH7 | WUFTH6 | WUFTH5 | WUFTH4 | WUFTH3 | WUFTH2 | WUFTH1 | WUFTH0 | 00100000    |
| Bit7   | Bit6   | Bit5   | Bit4   | Bit3   | Bit2   | Bit1   | Bit0   |             |

I<sup>2</sup>C Address: 0x5Ah



# ± 2g Tri-axis Digital Accelerometer Specifications

**PART NUMBER:**  
**KXTE9-2050**  
**Rev. 3**  
**Nov-2009**

## B2S\_THRESH

This register sets the B2S Threshold that is used to detect the transition from activity to inactivity. The KXTE9 ships from the factory with B2S\_THRESH set to a change in acceleration of 1.5g.

| R/W    | R/W    | R/W    | R/W    | R/W    | R/W    | R/W    | R/W    | Reset Value |
|--------|--------|--------|--------|--------|--------|--------|--------|-------------|
| B2STH7 | B2STH6 | B2STH5 | B2STH4 | B2STH3 | B2STH2 | B2STH1 | B2STH0 | 01100000    |
| Bit7   | Bit6   | Bit5   | Bit4   | Bit3   | Bit2   | Bit1   | Bit0   |             |

I<sup>2</sup>C Address: 0x5Bh

## TILT\_ANGLE

This register sets the tilt angle that is used to detect the transition from Face-up/Face-down states to Screen Rotation states. The KXTE9 ships from the factory with tilt angle set to a low threshold of 26° from horizontal. A different default tilt angle can be requested from the factory. Note that the minimum suggested tilt angle is 10°.

| R/W  | R/W  | R/W  | R/W  | R/W  | R/W  | R/W  | R/W  | Reset Value |
|------|------|------|------|------|------|------|------|-------------|
| TA7  | TA6  | TA5  | TA4  | TA3  | TA2  | TA1  | TA0  | 00011100    |
| Bit7 | Bit6 | Bit5 | Bit4 | Bit3 | Bit2 | Bit1 | Bit0 |             |

I<sup>2</sup>C Address: 0x5Ch

## HYST\_SET

This register sets the Hysteresis that is placed in between the Screen Rotation states. The KXTE9 ships from the factory with HYST\_SET set to +/-15° of hysteresis. A different default hysteresis can be requested from the factory. Note that when writing a new value to this register the current values of RES0 and RES1 must be preserved. These values are set at the factory and must not change.

| R/W  | R/W  | R/W  | R/W  | R/W   | R/W   | R/W   | R/W   | Reset Value |
|------|------|------|------|-------|-------|-------|-------|-------------|
| RES1 | RES0 | 0    | 0    | HYST3 | HYST2 | HYST1 | HYST0 | --001000    |
| Bit7 | Bit6 | Bit5 | Bit4 | Bit3  | Bit2  | Bit1  | Bit0  |             |

I<sup>2</sup>C Address: 0x5Fh

|   |   |   |
|---|---|---|
|  | <b>± 2g Tri-axis Digital Accelerometer Specifications</b> | <b>PART NUMBER:</b><br>KXTE9-2050<br>Rev. 3<br>Nov-2009 |
|---|---|---|

## KXTE9 Embedded Applications

### Orientation Detection Feature

The orientation detection feature of the KXTE9 will report changes in face up, face down, ± vertical and ± horizontal orientation. This intelligent embedded algorithm considers very important factors that provide accurate orientation detection from low cost tri-axis accelerometers. Factors such as: hysteresis, device orientation angle and delay time are described below as these techniques are utilized inside the KXTE9.

#### Hysteresis

A 45° tilt angle threshold seems like a good choice because it is halfway between 0° and 90°. However, a problem arises when the user holds the device near 45°. Slight vibrations, noise and inherent sensor error will cause the acceleration to go above and below the threshold rapidly and randomly, so the screen will quickly flip back and forth between the 0° and the 90° orientations. This problem is avoided in the KXTE9 by choosing a hysteresis angle. With a ±15° hysteresis angle, the screen will not rotate from 0° to 90° until the device is tilted to 60° (45°+15°). To rotate back to 0°, the user must tilt back to 30° (45°-15°), thus avoiding the screen flipping problem. Table 16 shows the acceleration limits implemented for ±15° of hysteresis in between the four screen rotation states.

| Orientation | X Acceleration (g) | Y Acceleration (g) |
|-------------|--------------------|--------------------|
| 0°/360°     | $-0.5 < a_x < 0.5$ | $a_y > 0.866$      |
| 90°         | $a_x > 0.866$      | $-0.5 < a_y < 0.5$ |
| 180°        | $-0.5 < a_x < 0.5$ | $a_y < -0.866$     |
| 270°        | $a_x < -0.866$     | $-0.5 < a_y < 0.5$ |

**Table 16.** Acceleration at the four orientations with ±15° of hysteresis

The KXTE9 allows the user to change the amount of hysteresis in between the four screen rotation states. By simply writing to the HYST\_SET register, the user can adjust the amount of hysteresis from ±3° to ±30°. The plot in Figure 1 shows the typical amount of hysteresis applied for a given digital count value.



# ± 2g Tri-axis Digital Accelerometer Specifications

PART NUMBER:  
KXTE9-2050  
Rev. 3  
Nov-2009

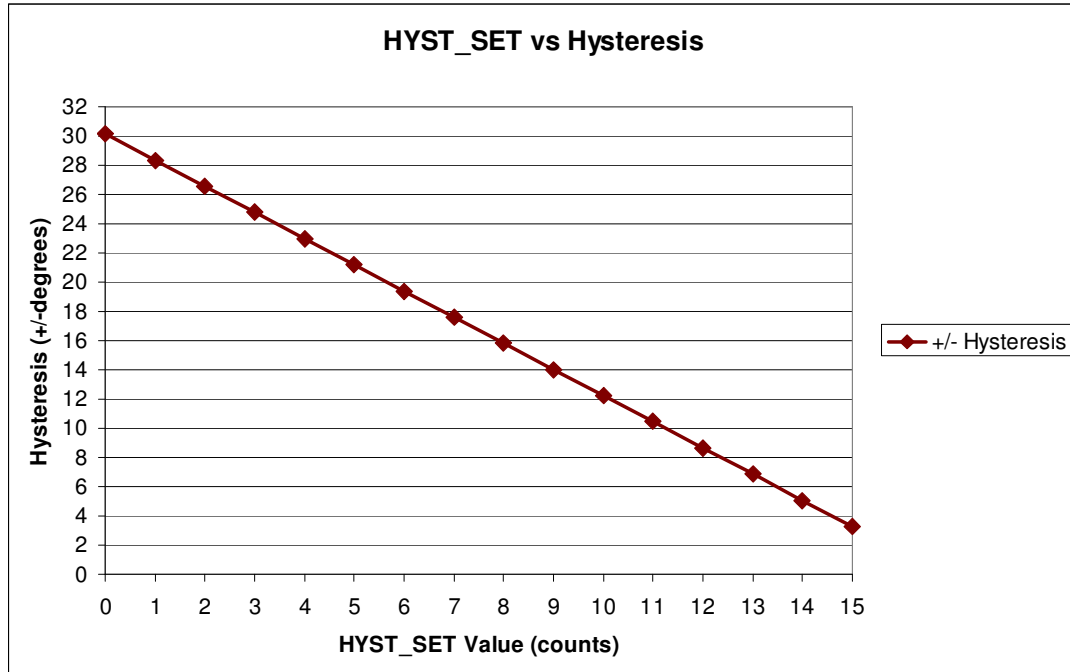

Figure 1. Hysteresis vs. HYST\_SET value

## Device Orientation Angle (aka Tilt Angle)

To ensure that horizontal and vertical device orientation changes are detected, even when it isn't in the ideal vertical orientation – where the angle  $\theta$  in Figure 2 is  $90^\circ$ , the KXTE9 considers device orientation angle in its algorithm.

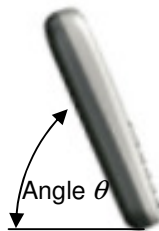

Figure 2. Device Orientation Angle

As the angle in Figure 2 is decreased, the maximum gravitational acceleration on the X-axis or Y-axis will also decrease. Therefore, when the angle becomes small enough, the user will not be able to make the screen orientation change. When the device orientation angle approaches  $0^\circ$  (device is flat on a desk or table),  $a_x = a_y = 0g$ ,  $a_z = +1g$ , and there is no way to determine which way the



## ± 2g Tri-axis Digital Accelerometer Specifications

PART NUMBER:  
KXTE9-2050  
Rev. 3  
Nov-2009

screen should be oriented, the internal algorithm determines that the device is in either the face-up or face-down orientation, depending on the sign of the z-axis. The KXTE9 will only change the screen orientation when the orientation angle is above the factory-defaulted/user-defined threshold set in the TILT\_ANGLE register. Equation 2 can be used to determine what value to write to the TILT\_ANGLE register to set the device orientation angle.

$$\text{TILT\_ANGLE (counts)} = \sin \theta * (\text{Sensitivity (counts/g)} * 4)$$

**Equation 2.** Device Orientation Angle (aka Tilt Angle)

### Tilt Timer

The 8-bit register, TILT\_TIMER can be used to qualify changes in orientation. The KXTE9 does this by incrementing a counter with a size that is specified by the value in TILT\_TIMER for each set of acceleration samples to verify that a change to a new orientation state is maintained. A user defined output data rate (ODR) determines the time period for each sample. Equation 3 shows how to calculate the TILT\_TIMER register value for a desired delay time.

$$\text{TILT\_TIMER (counts)} = \text{Delay Time (sec)} * \text{ODR (Hz)}$$

**Equation 3.** Tilt Position Delay Time

|   |   |   |
|---|---|---|
|  | <b>± 2g Tri-axis Digital Accelerometer<br/>Specifications</b> | <b>PART NUMBER:</b><br>KXTE9-2050<br>Rev. 3<br>Nov-2009 |
|---|---|---|

### Active/Inactive Feature Description

The Active/Inactive feature of the KXTE9 reports qualified changes in acceleration based Wake Up (WUF) and Back to Sleep (B2S) thresholds. If the change in acceleration on any axis is greater than the user-defined wake up threshold (WUF\_THRESH), the device has transitioned from an inactive state to an active state. Equation 4 shows how to calculate the WUF\_THRESH register value for a desired wake up threshold.

$$\text{WUF\_THRESH (counts)} = 4 \times (\text{Wake Up Threshold (g)} \times \text{Sensitivity (counts/g)})$$

#### Equation 4. Wake Up Threshold

If the change in acceleration on any axis is less than the user-defined back to sleep threshold (B2S\_THRESH), the device has transitioned from an active state to an inactive state. Equation 5 shows how to calculate the B2S\_THRESH register value for a desired wake up threshold.

$$\text{B2S\_THRESH (counts)} = 4 \times (\text{Back to Sleep Threshold (g)} \times \text{Sensitivity (counts/g)})$$

#### Equation 5. Back to Sleep Threshold

Separate WUF (WUF\_TIMER) and B2S (B2S\_TIMER) 8-bit raw unsigned values represent counters that permit the user to qualify each active/inactive state change. Note that each WUF Timer count qualifies 1 (one) user-defined ODR period (OB2S) and each B2S Timer count qualifies 16 (sixteen) user-defined periods (initial ODR or OWUF). Equation 6 shows how to calculate the WUF\_TIMER register value for a desired wake up delay time.

$$\text{WUF\_TIMER (counts)} = \text{Wake Up Delay Time (sec)} \times \text{OB2S (Hz)}$$

#### Equation 6. Wake Up Delay Time

Equation 7 shows how to calculate the B2S\_TIMER register value for a desired back to sleep delay time.

$$\text{B2S\_TIMER (counts)} = (\text{Back to Sleep Delay Time (sec)} \times \text{OWUF (Hz)}) / 16$$

#### Equation 7. Back to Sleep Delay Time

Figure 3 shows the response of the Active/Inactive algorithm with WUF Timer = 10 counts and B2S Timer = 10 counts.





# ± 2g Tri-axis Digital Accelerometer Specifications

PART NUMBER:  
KXTE9-2050  
Rev. 3  
Nov-2009

## Typical Active/Inactive Interrupt Example

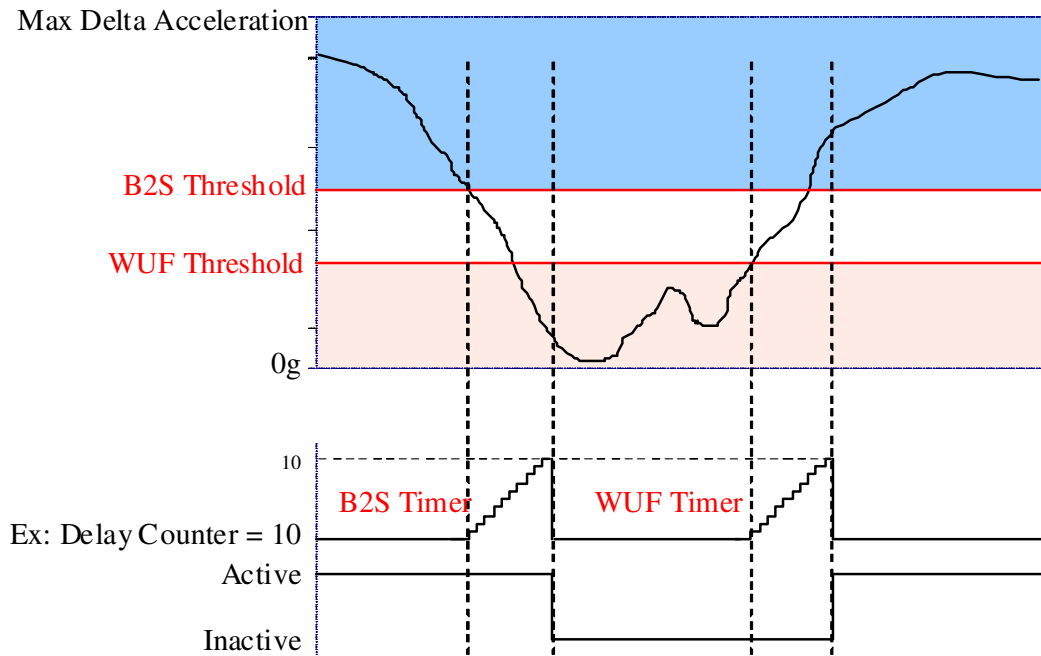



Figure 3. KXTE9 Inactive/Active Transitions

|   |   |  |
|---|---|--|
|  | <b>± 2g Tri-axis Digital Accelerometer<br/>Specifications</b> | <b>PART NUMBER:</b><br><b>KXTE9-2050</b><br><b>Rev. 3</b><br><b>Nov-2009</b> |
|---|---|--|

### Revision History

| REVISION | DESCRIPTION   | DATE        |
|----------|---|-------------|
| 1        | Initial release   | 09-Apr-2009 |
| 2        | Updated thermal performance   | 14-Aug-2009 |
| 3        | Corrected typographical errors and clarified some confusing definitions | 05-Nov-2009 |

"Kionix" is a registered trademark of Kionix, Inc. Products described herein are protected by patents issued or pending. No license is granted by implication or otherwise under any patent or other rights of Kionix. The information contained herein is believed to be accurate and reliable but is not guaranteed. Kionix does not assume responsibility for its use or distribution. Kionix also reserves the right to change product specifications or discontinue this product at any time without prior notice. This publication supersedes and replaces all information previously supplied.